

# **Cahier de projet**

Florian Coruble et Jessica Cloutier

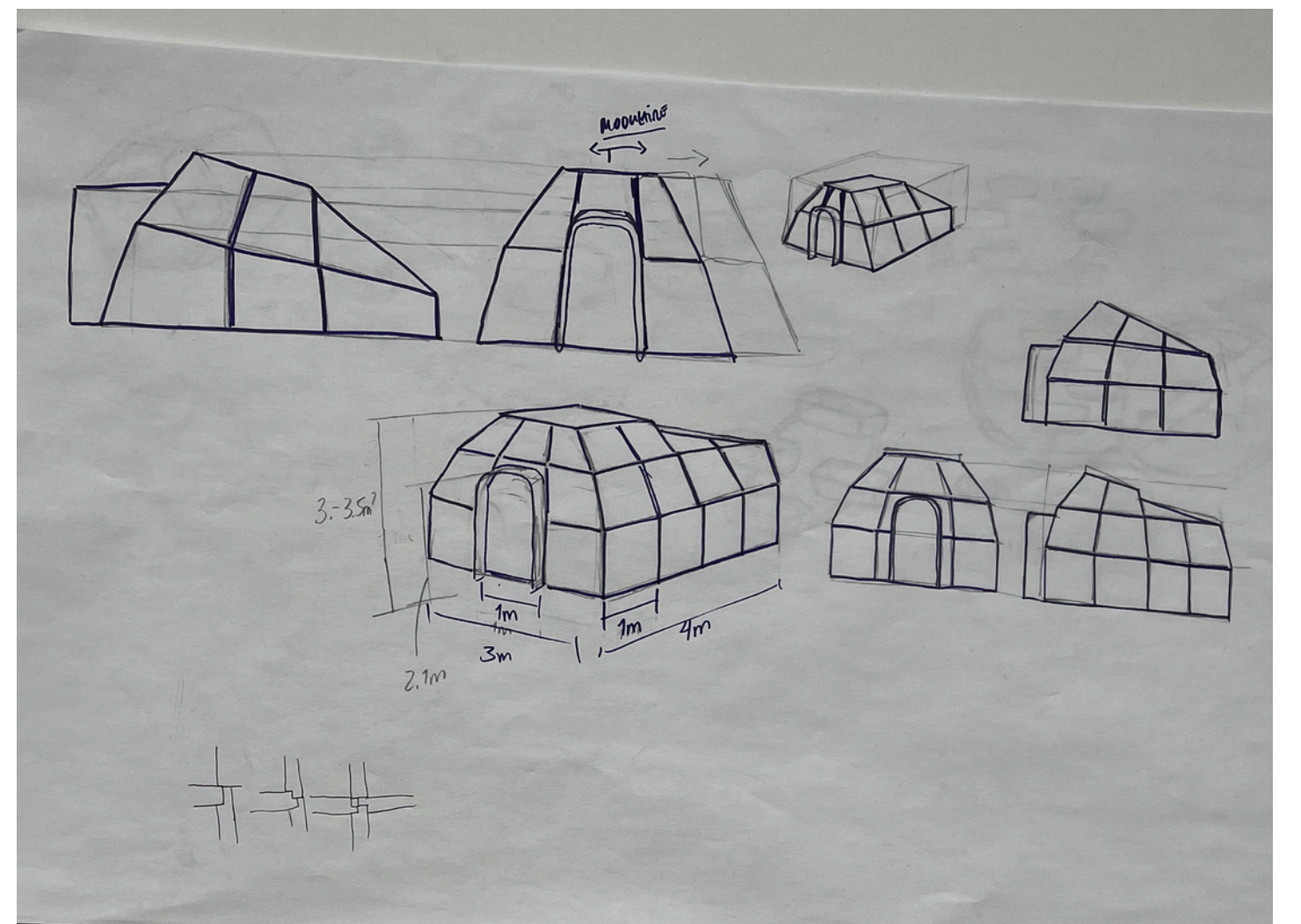

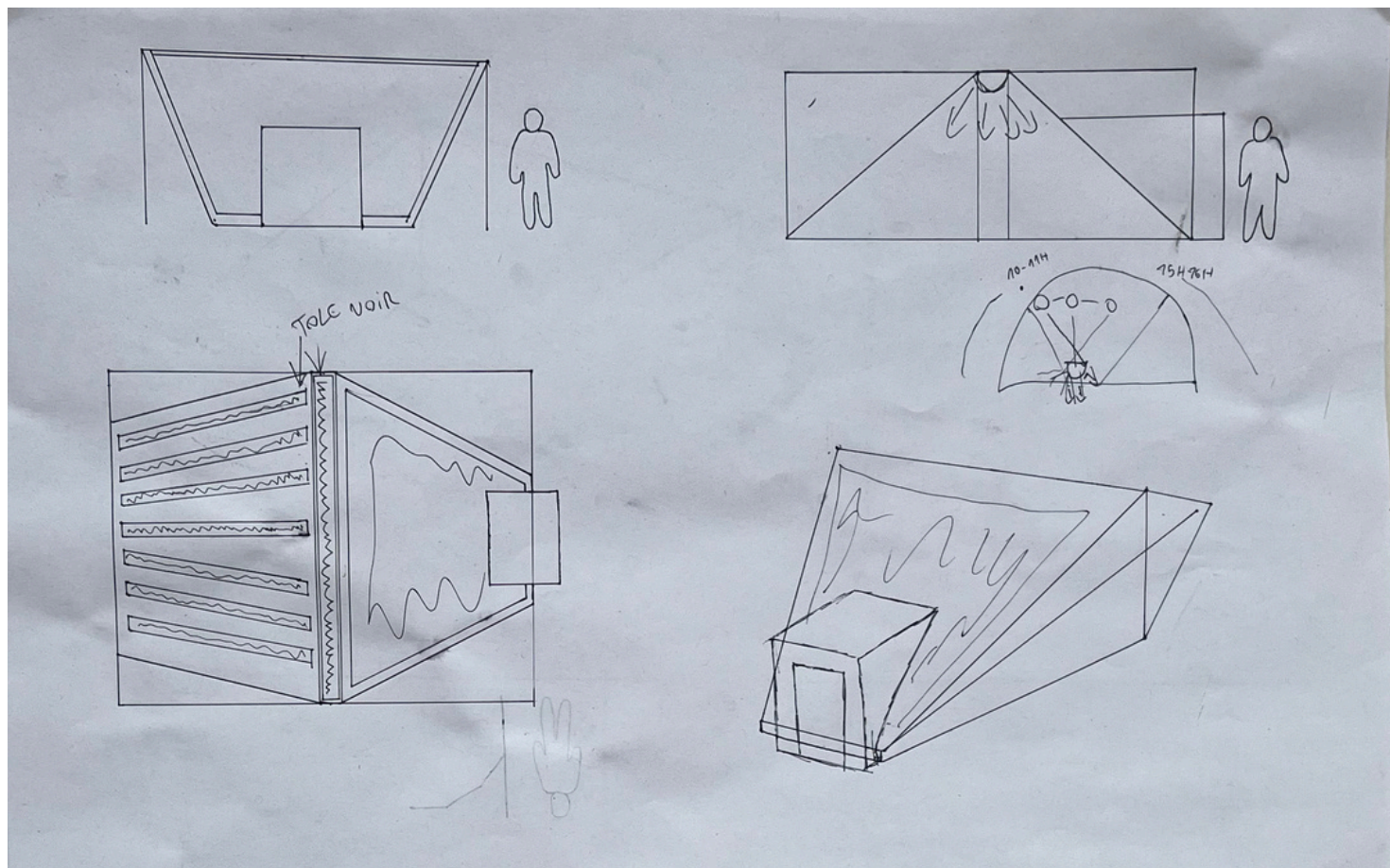

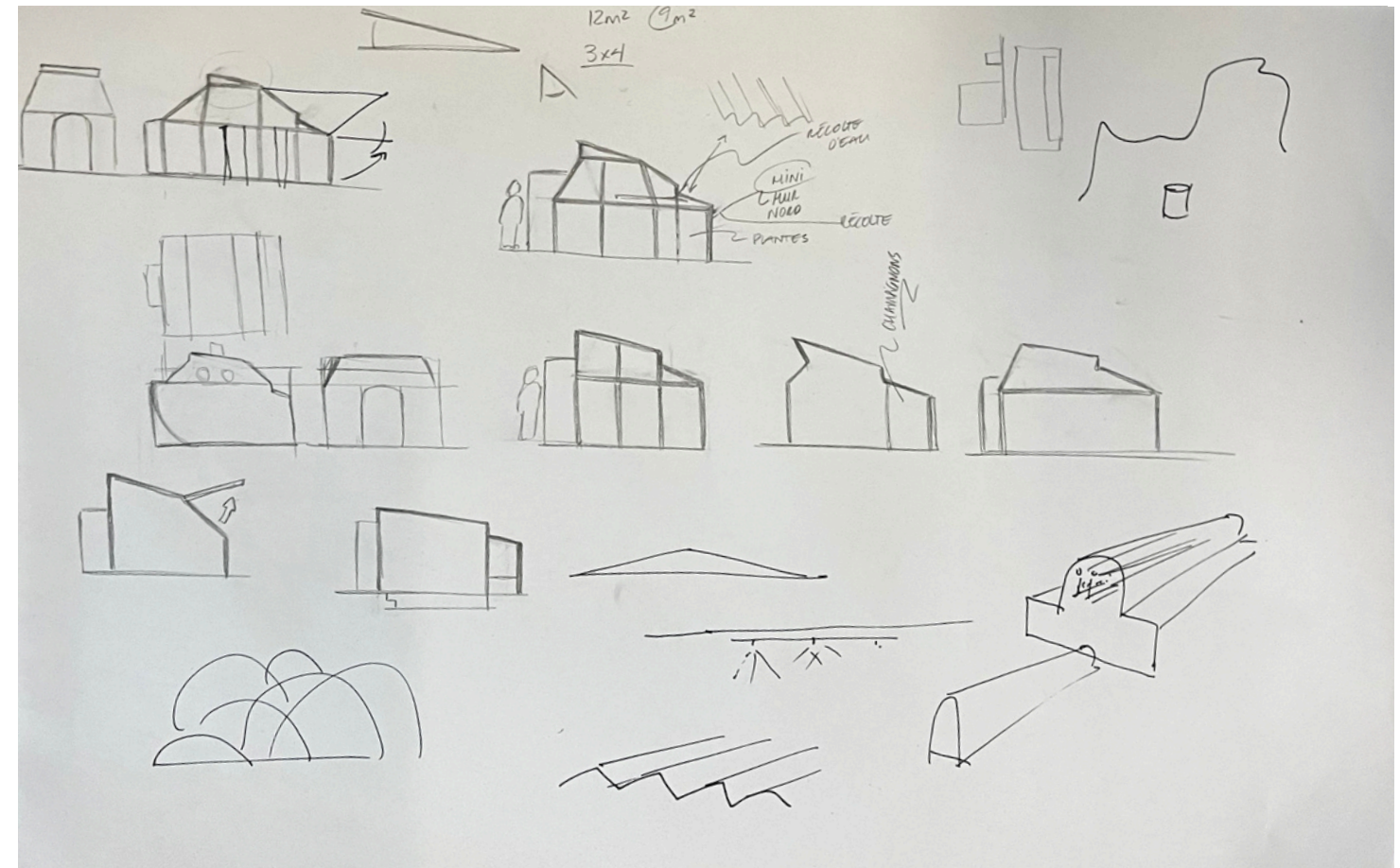
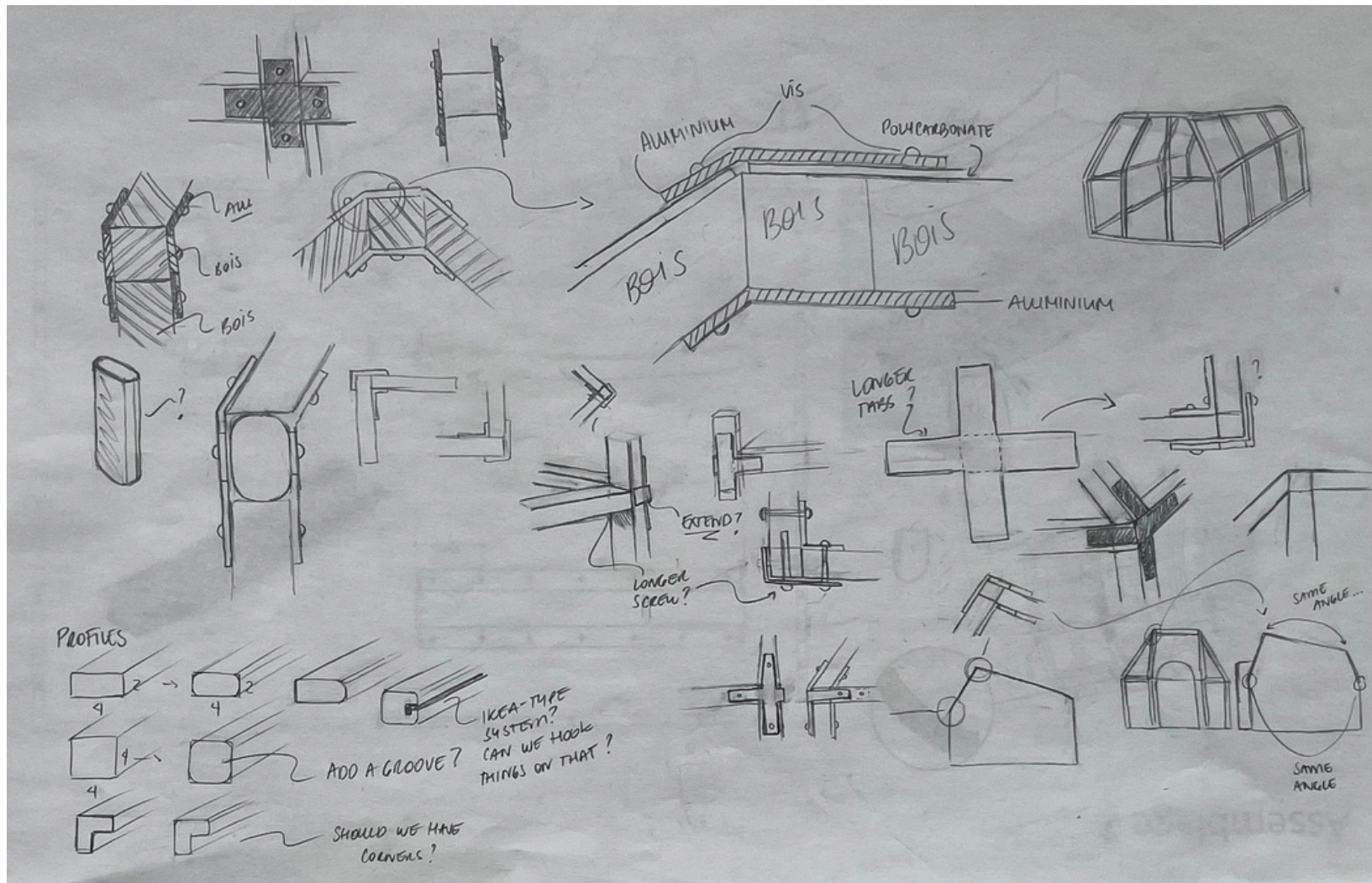
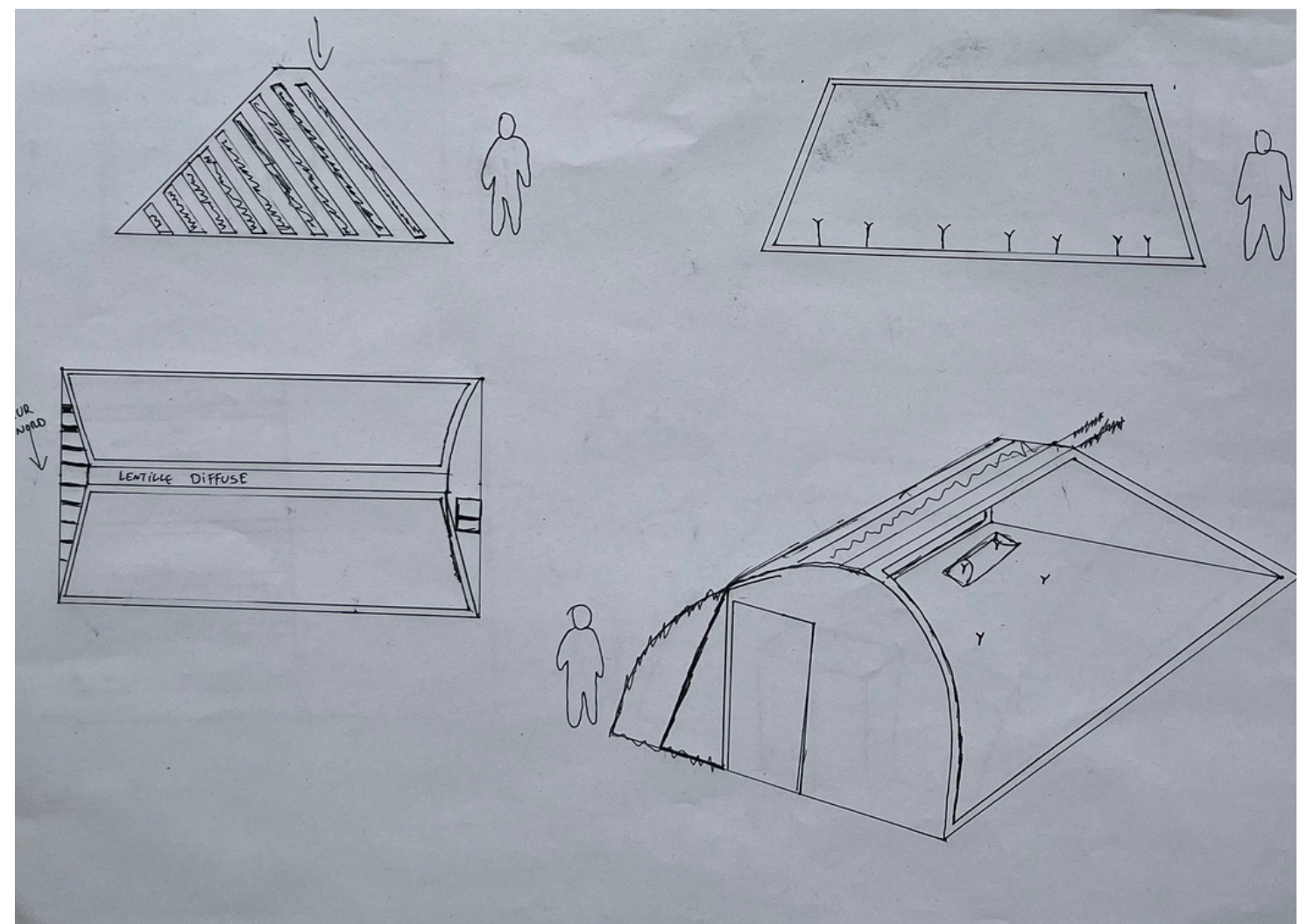
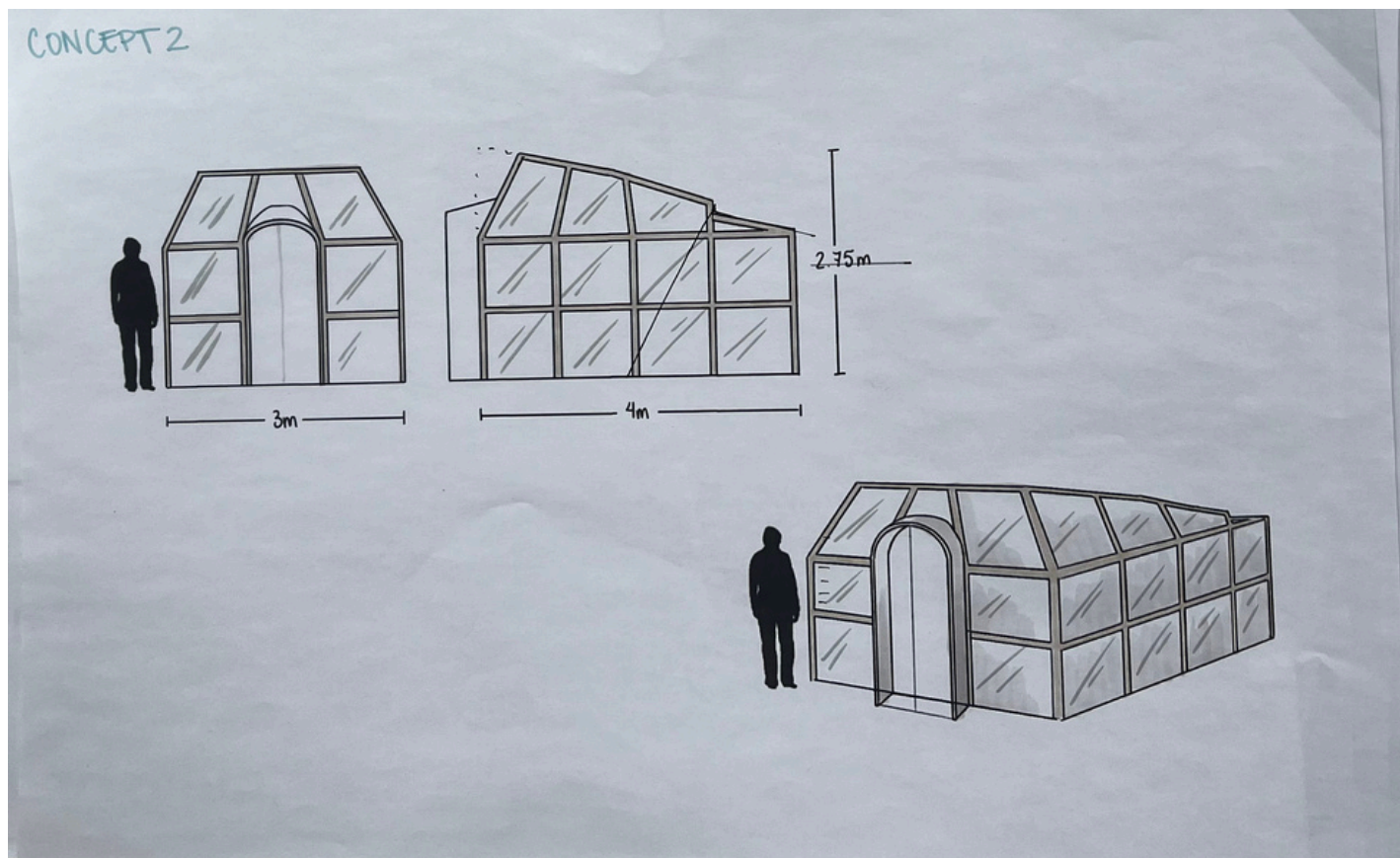
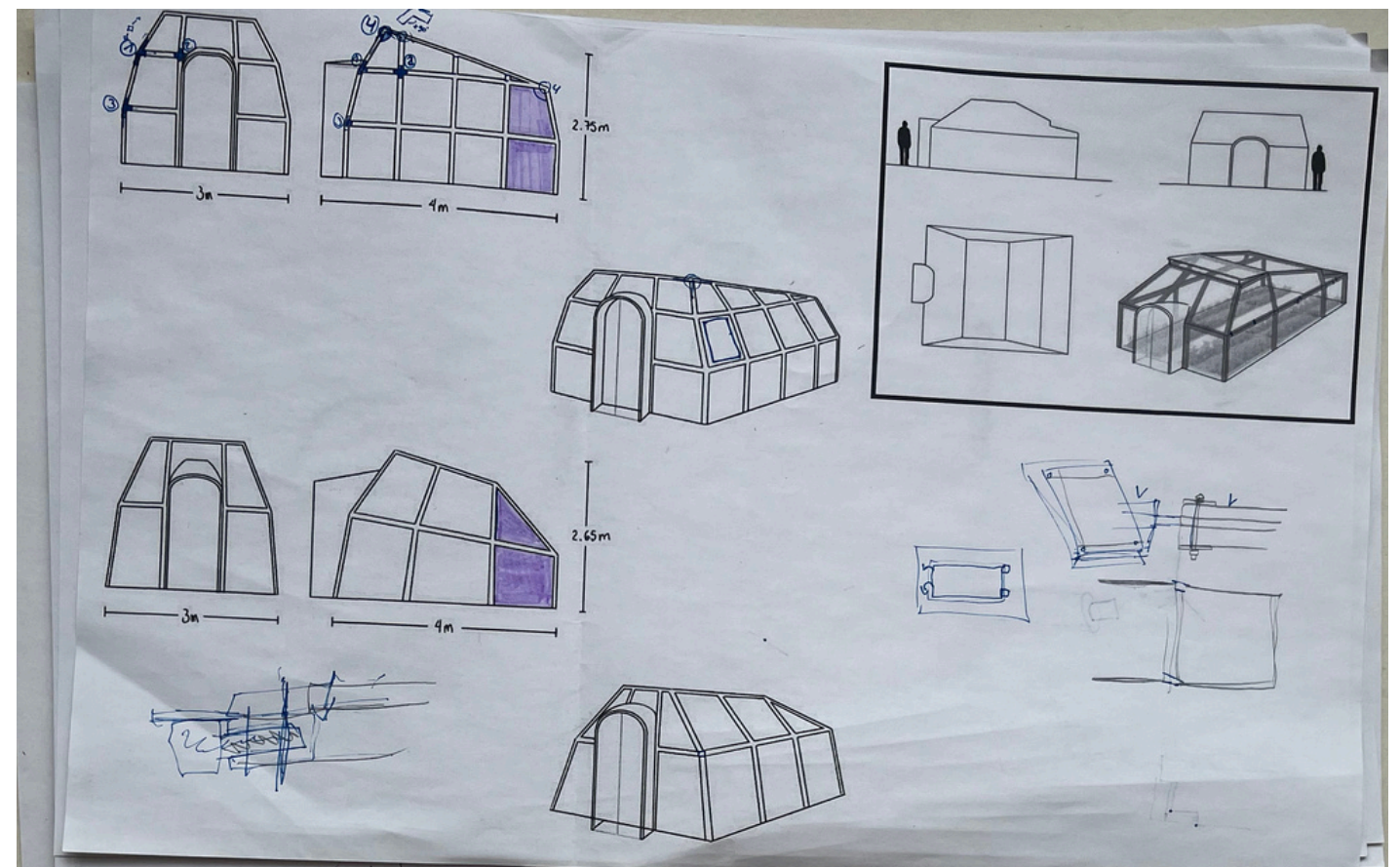
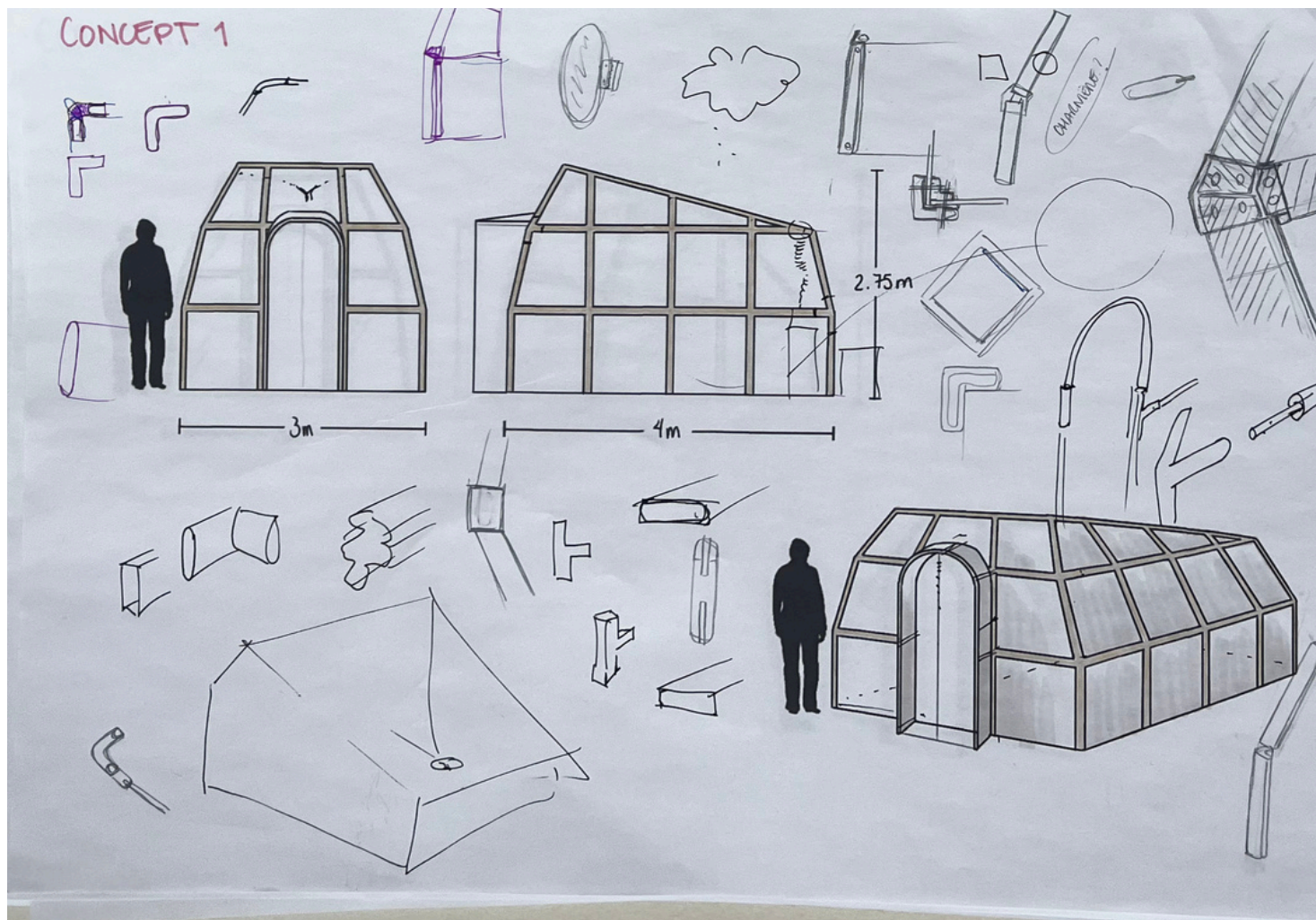
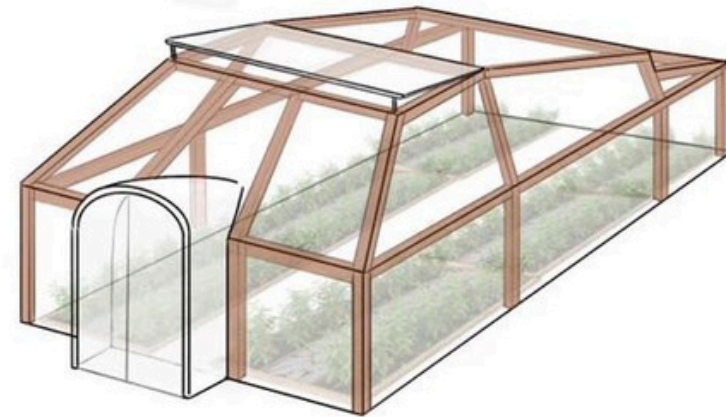
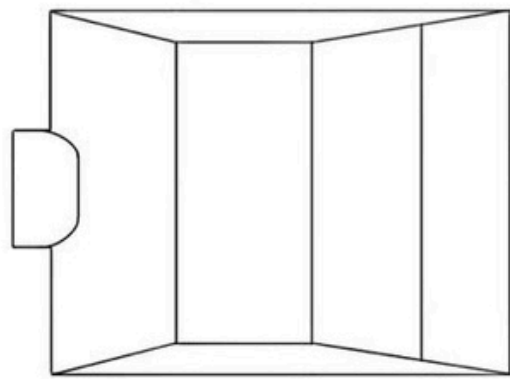
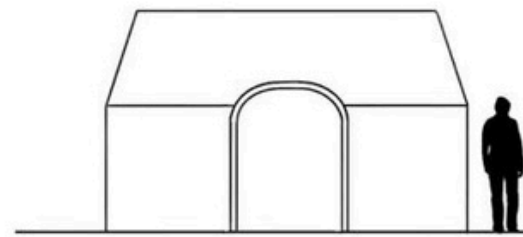
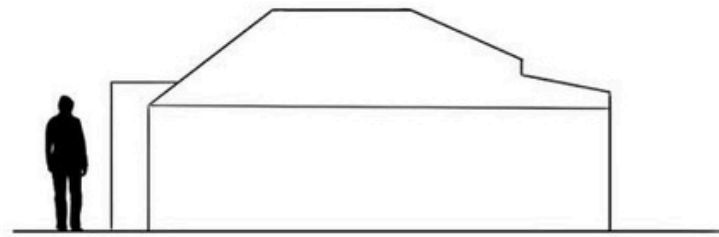
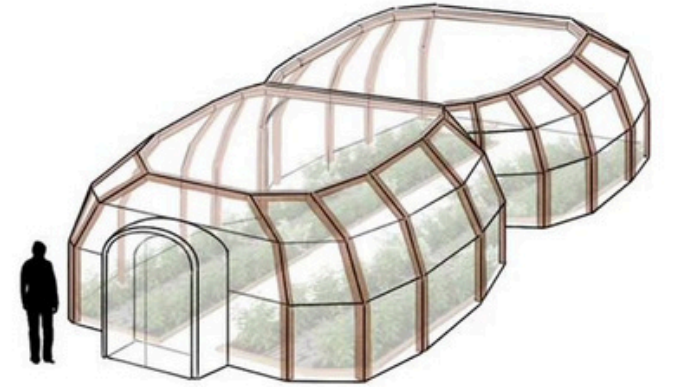
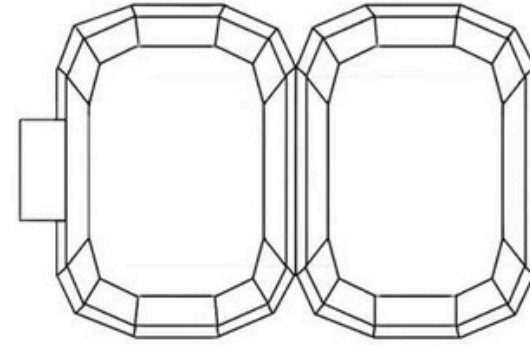
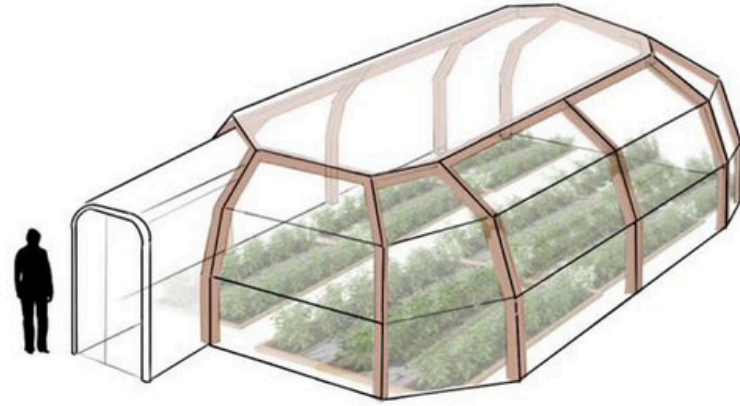
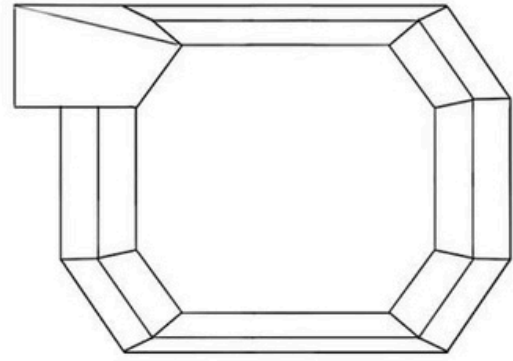
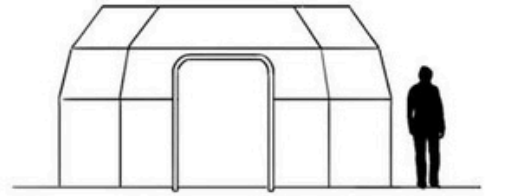
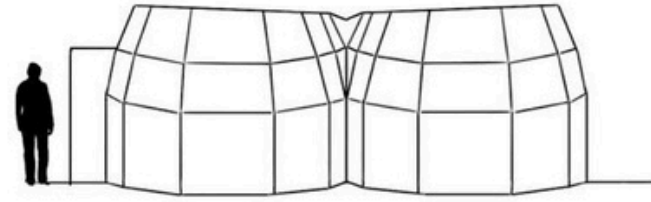
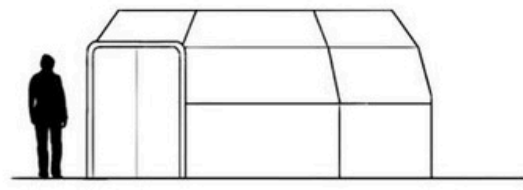
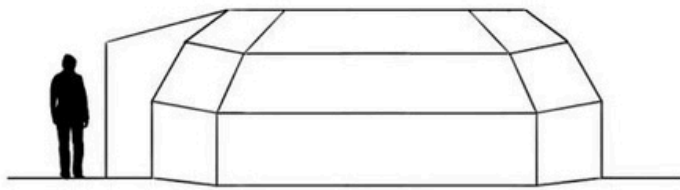

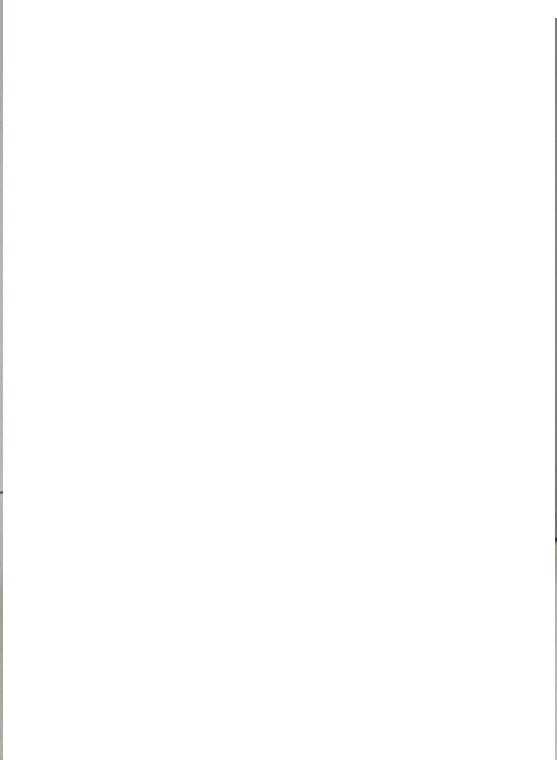
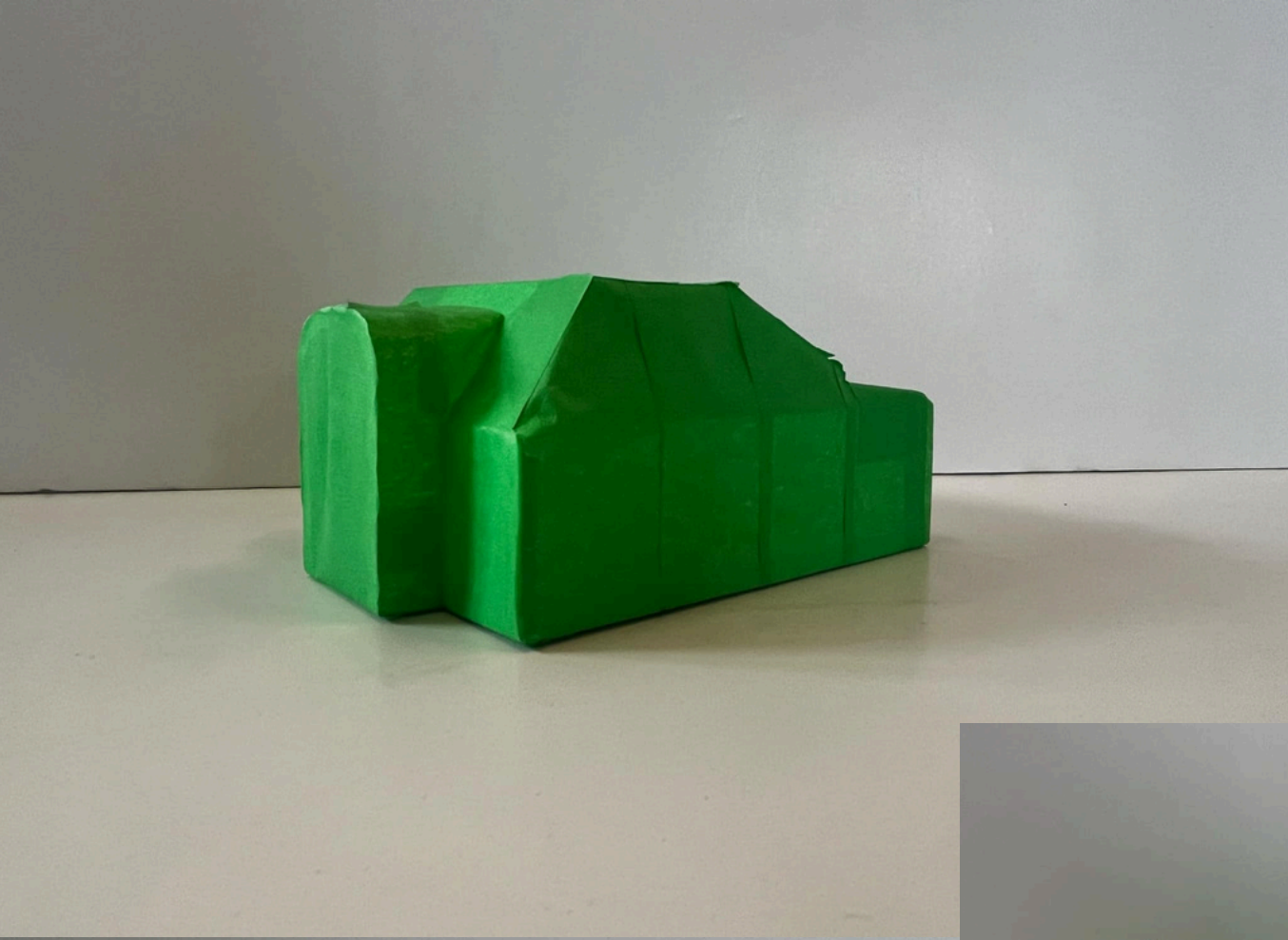

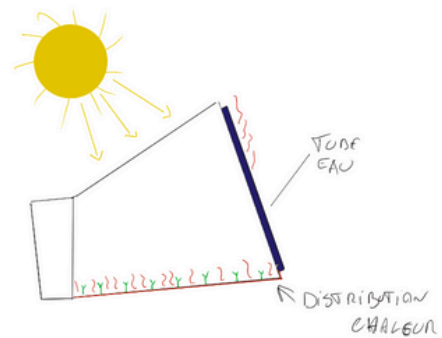
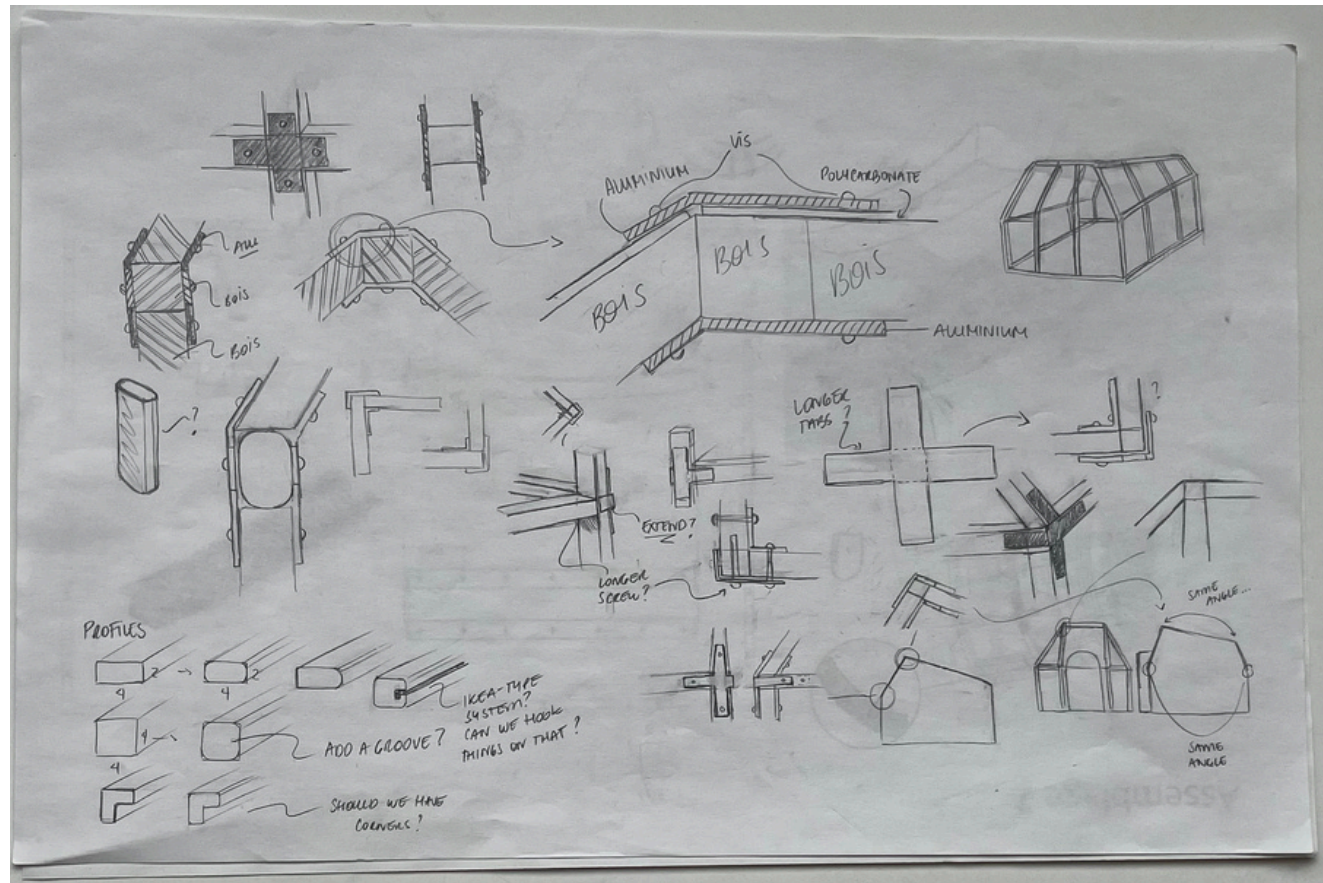

- CHALEUR  
- MODULARITE

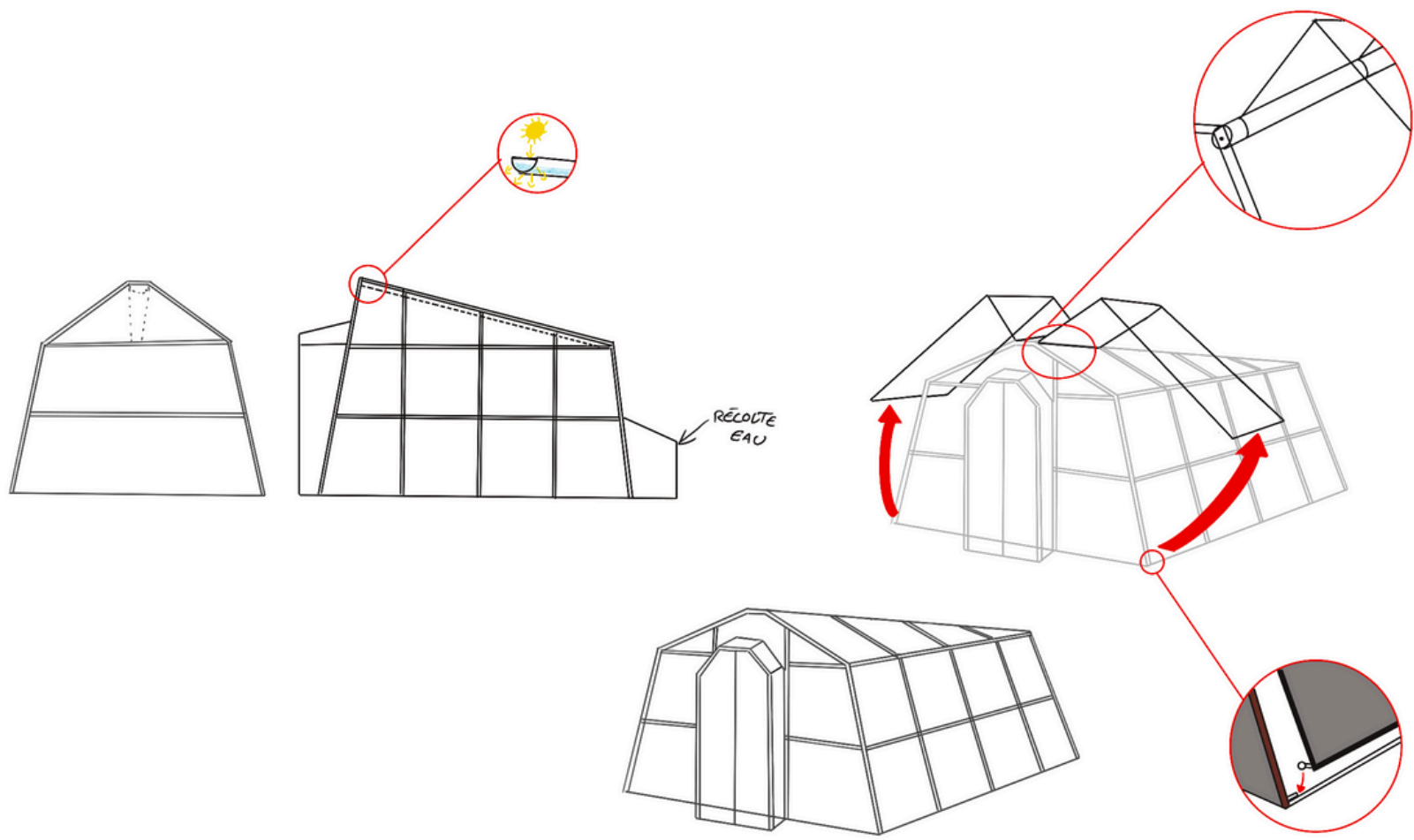
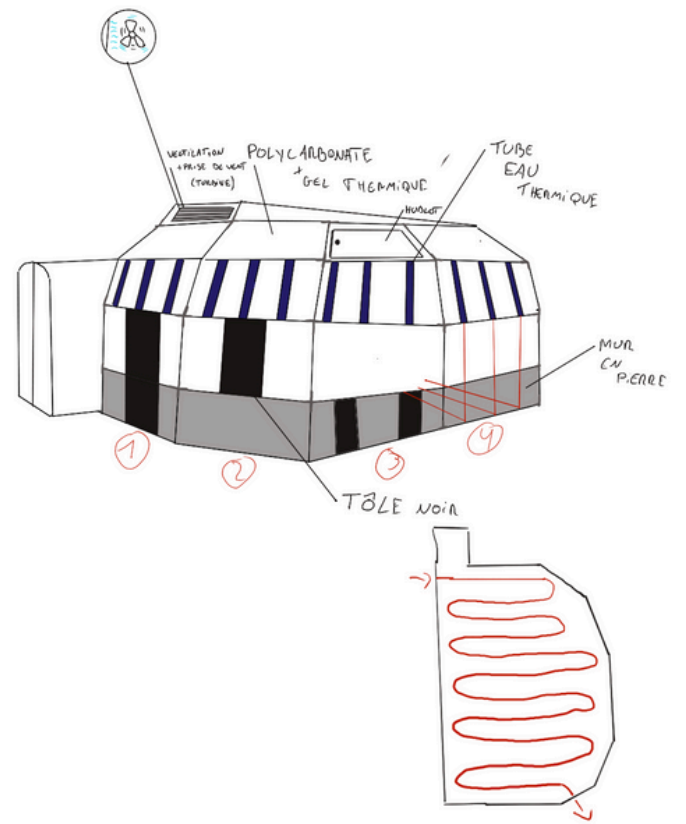

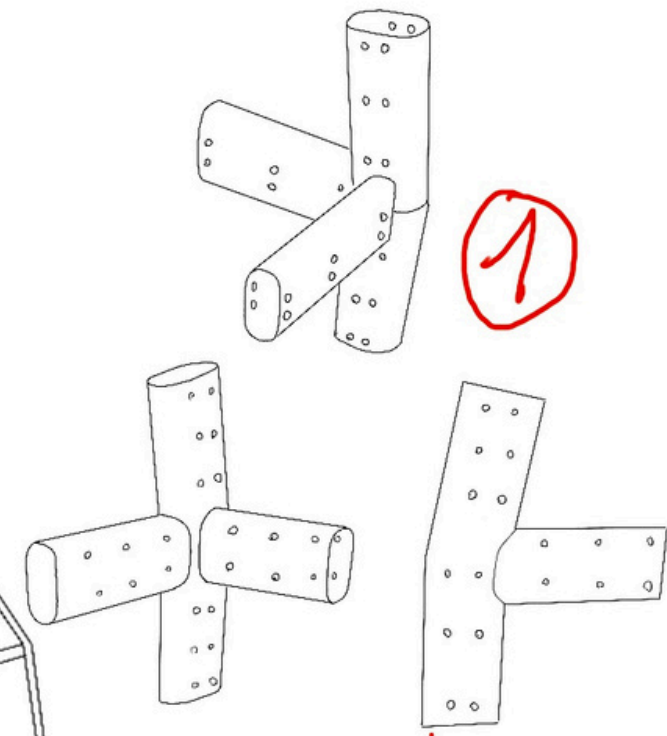
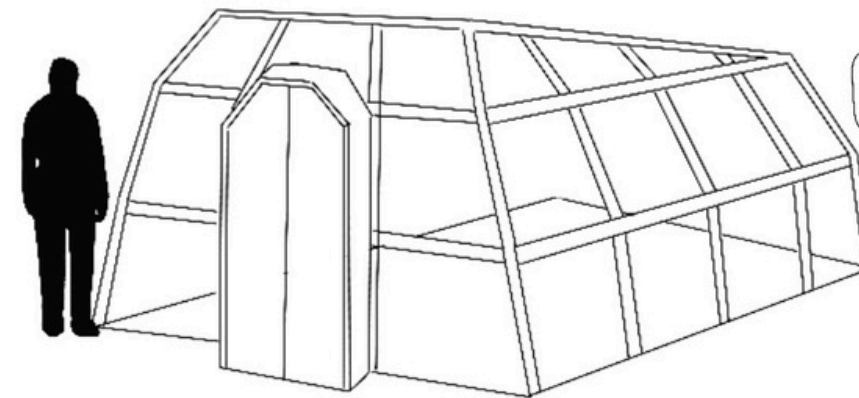
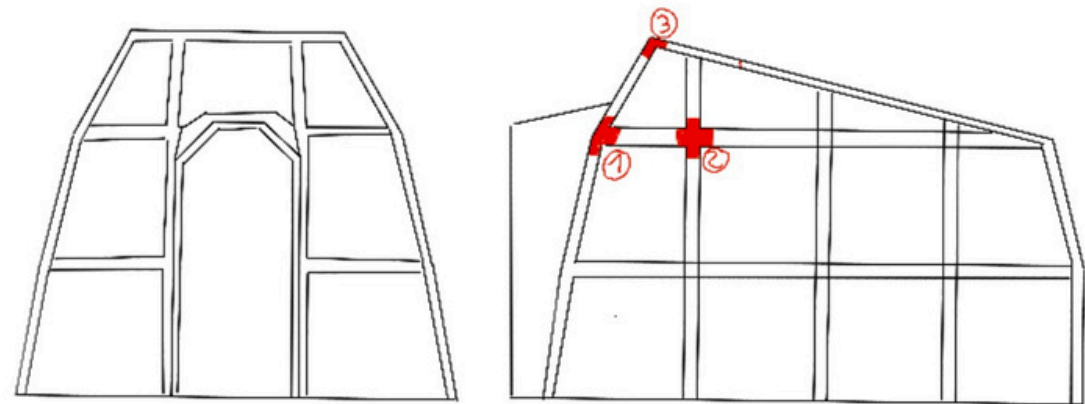
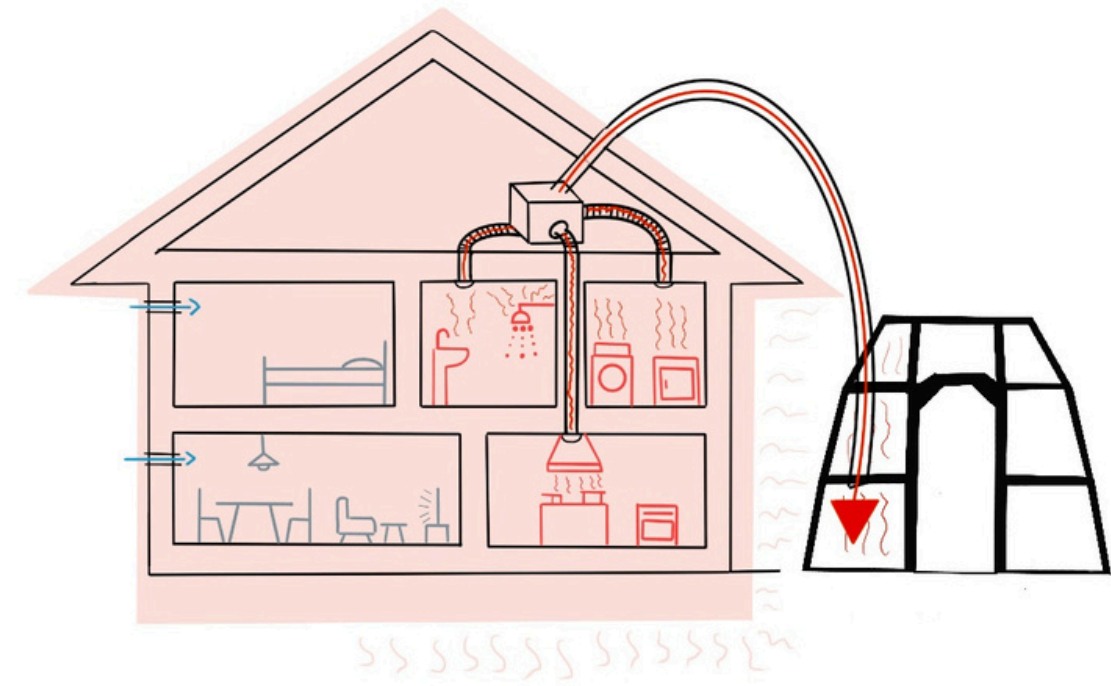
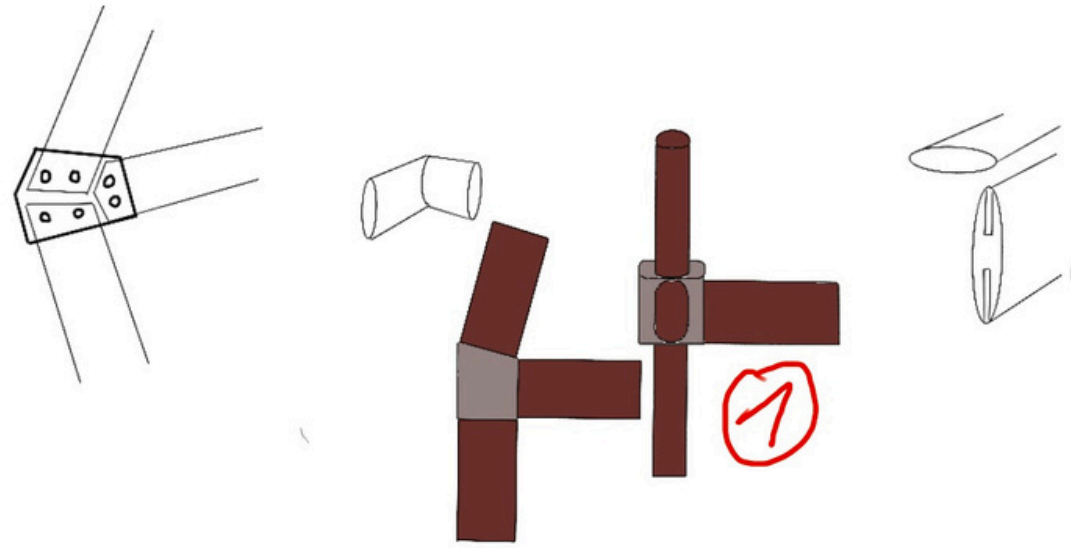

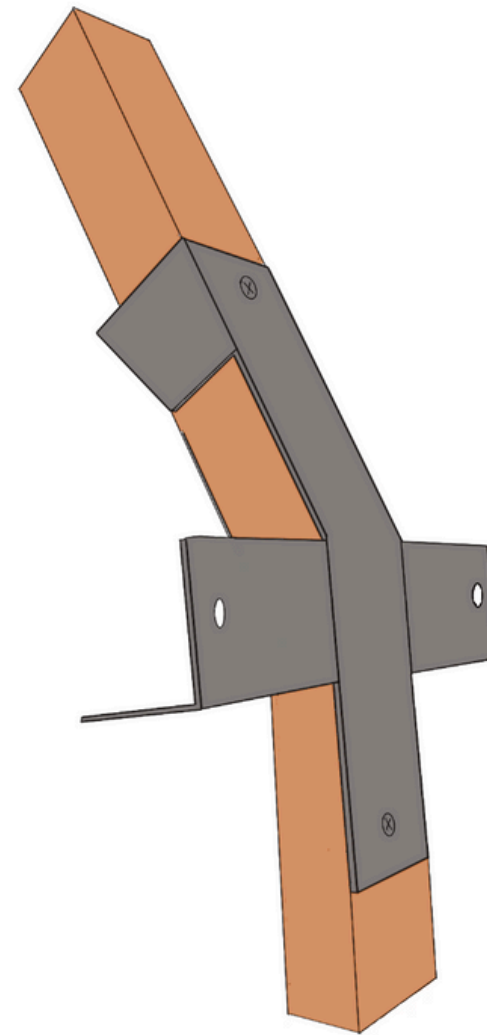
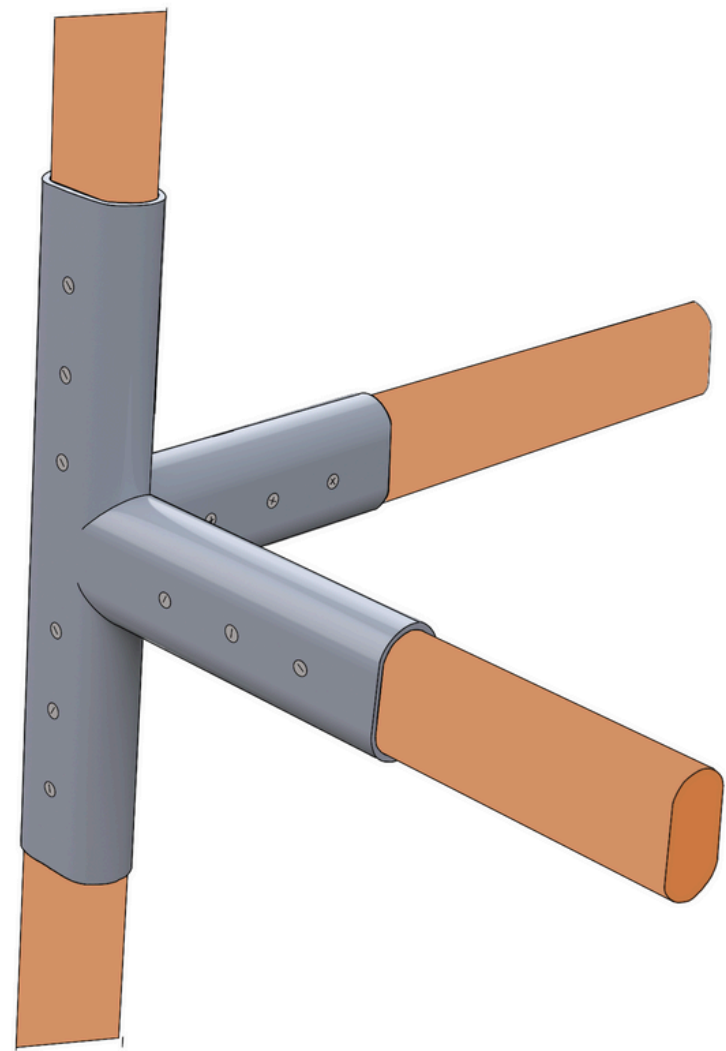





CAN YOU HAVE 'MUR NORD' PROPERTIES IN PLANT POTS?

HOW FUTURISTIC PROTECTS/ OBJECTS WERE SEEN

HERBS UPSIDE DOWN LONCE...

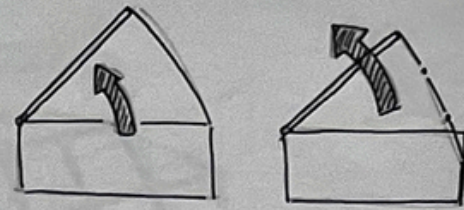
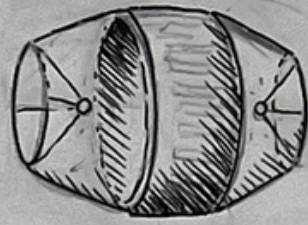
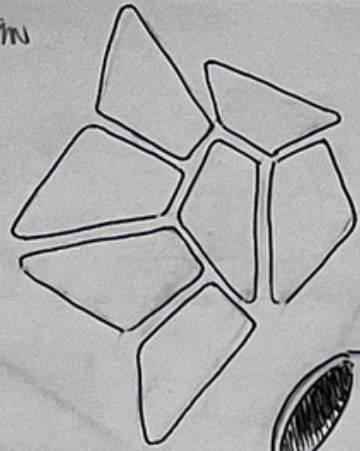
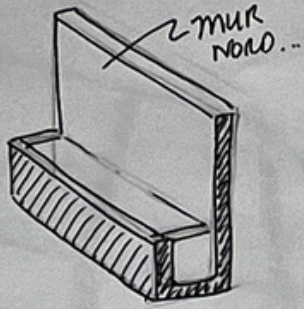

MOVE BUT WITHOUT WHEELS... SLED...

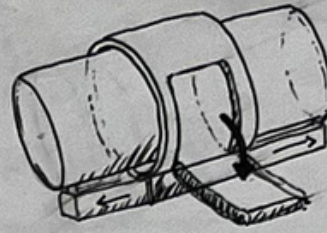
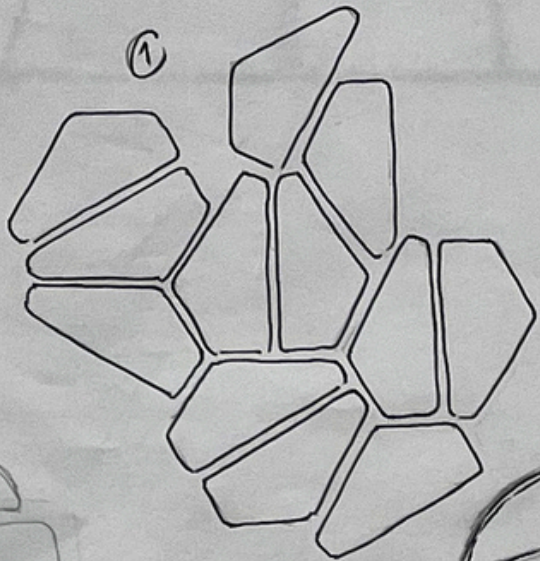
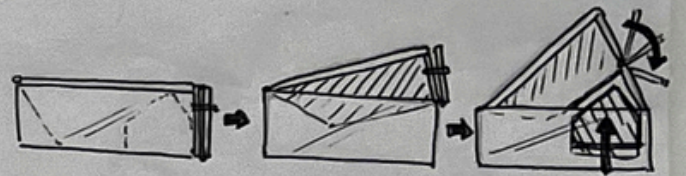

WHEN THE ROOF EXPANDS ITS ANGLE IN PARK?

